

TR4110BL







smeg 110cm Thermoseal freestanding cooker — 'THE VICTORIA'



TOP RIGHT OVEN (main)

					
vapour clean	bakers function	convection	fan grill	static grill	ECO fan forced

LOWER LEFT OVEN (auxiliary)

					
defrost	fan assisted	convection	base heat	fan grill	bakers function

**finish** black enamelled metal  
**installation** freestanding  
**size** 1100mmW x 600mmD x 895 min – 920mm max H (excluding 135mm splashback)

EAN 8017709171605

ELECTRIC OVEN

main oven (top right)

- 6 functions
- Thermoseal technology
- 70 litre capacity
- fully automatic — LED electronic clock/programmer
- triple-glazed oven door (side opening)
- Smeg Vapour Clean
- Ever-Clean enamel
- 4 shelf heights
- tangential cooling fan
- storage compartment

auxiliary oven (lower left)

- 6 functions
- Thermoseal technology
- 70 litre capacity
- triple-glazed oven door (side opening)
- Smeg Vapour Clean
- Ever-Clean enamel
- 4 shelf heights
- tangential cooling fan
- roof liner

STANDARD INCLUSIONS

2 x grill grid, 3 x chrome shelves, 1 x 20mm baking tray, 2 x 40mm baking tray, 2 x pair telescopic shelf guides

maximum current 36.25 amps, 8.7 kW  
 240 volt, 50Hz  
 hardwired, single phase

ELECTRIC GRILL

2700W

GAS HOB

**capacity** 7 zones, 48.5 mj/hr total —  
 1 x ultra-rapid triple wok, 16.5 mj/hr  
 2 x rapid 12 mj/hr max each  
 2 x semi rapid 7.5 mj/hr max  
 2 x auxiliary burner 3.9 mj/hr max

**gas input** set for natural gas, regulator supplied, adapt for ULPG, no regulator required

**safety** flame failure device fitted to each burner

**warranty** two years parts and labour

**STANDARD INCLUSIONS** cast-iron work stand, teppanyaki plate



TR4110BL

smeg 110cm Thermoseal freestanding cooker — 'THE VICTORIA'

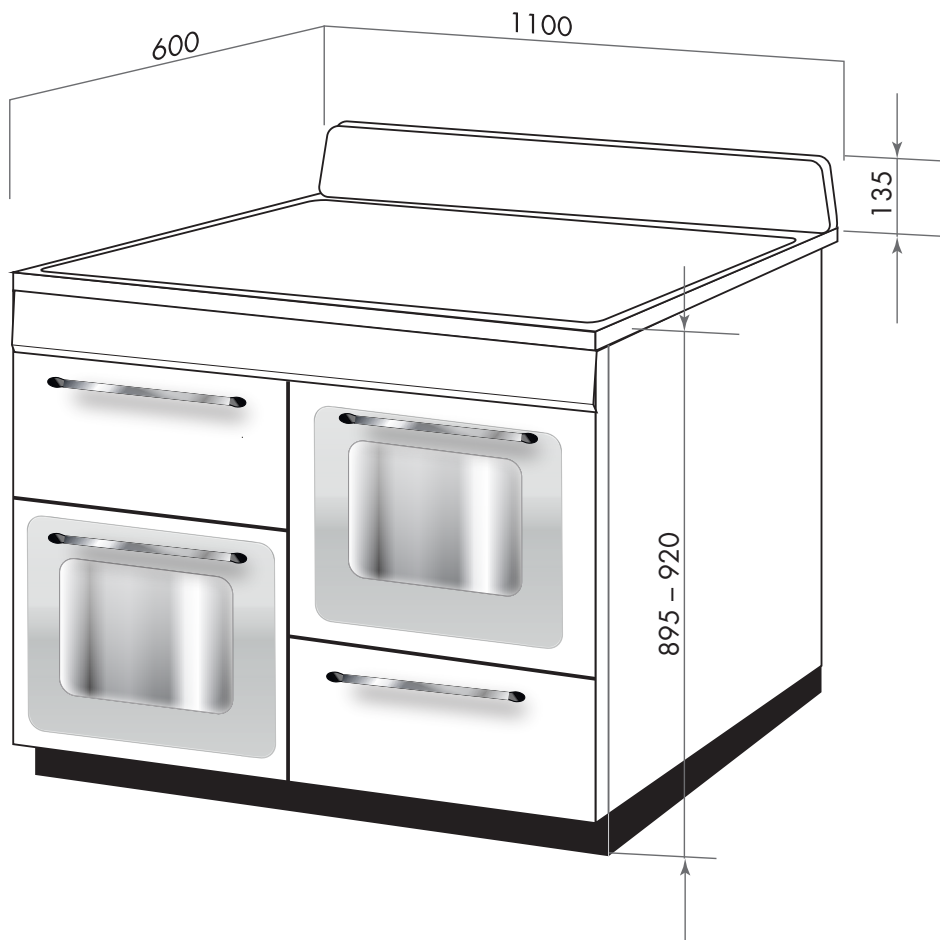

**PLEASE NOTE: drawings are not to scale. They are to assist only.**